

---

**JBL**<sup>®</sup>  
**GTO7001**  
**OWNER'S MANUAL**

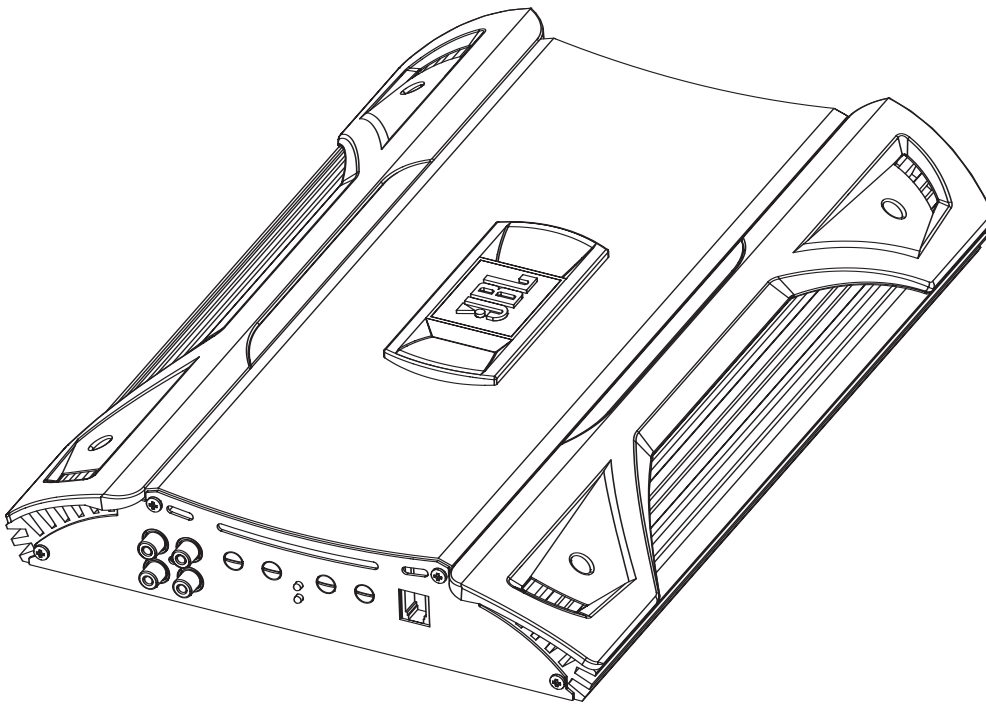

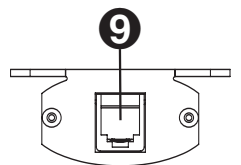
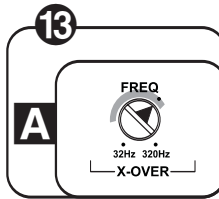
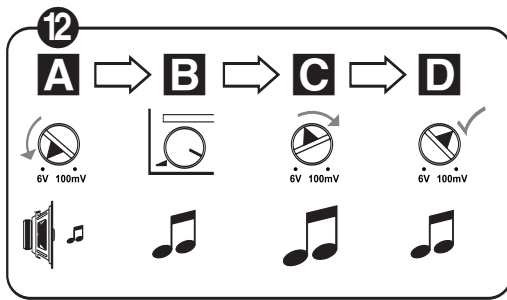
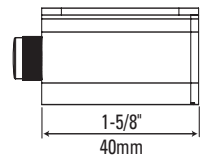
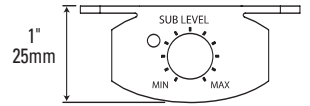
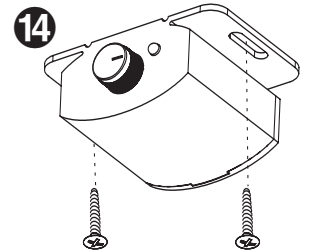
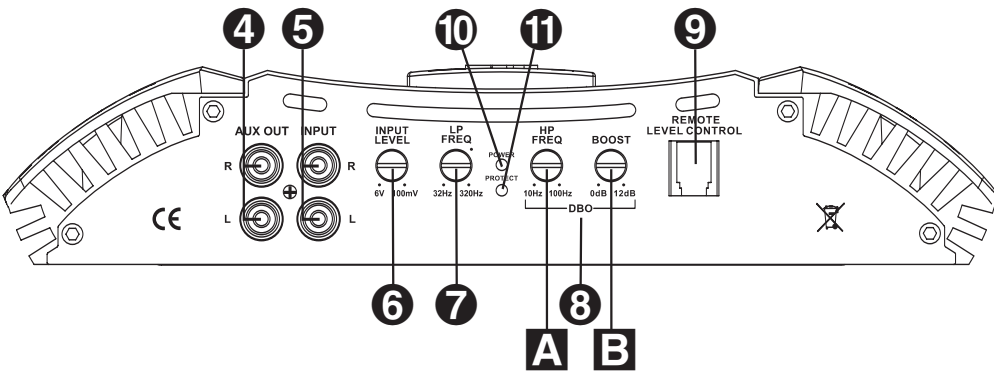
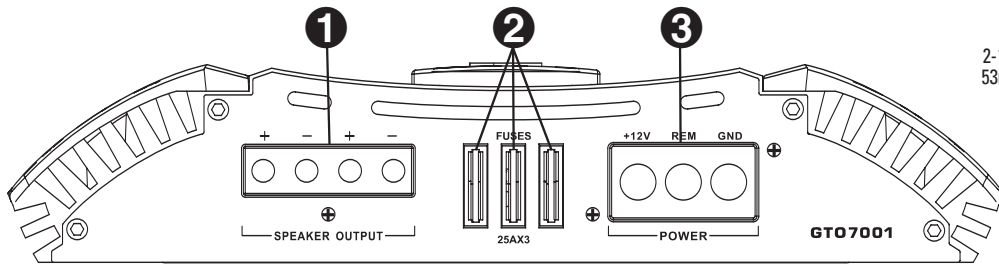
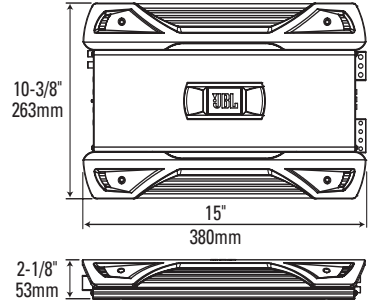
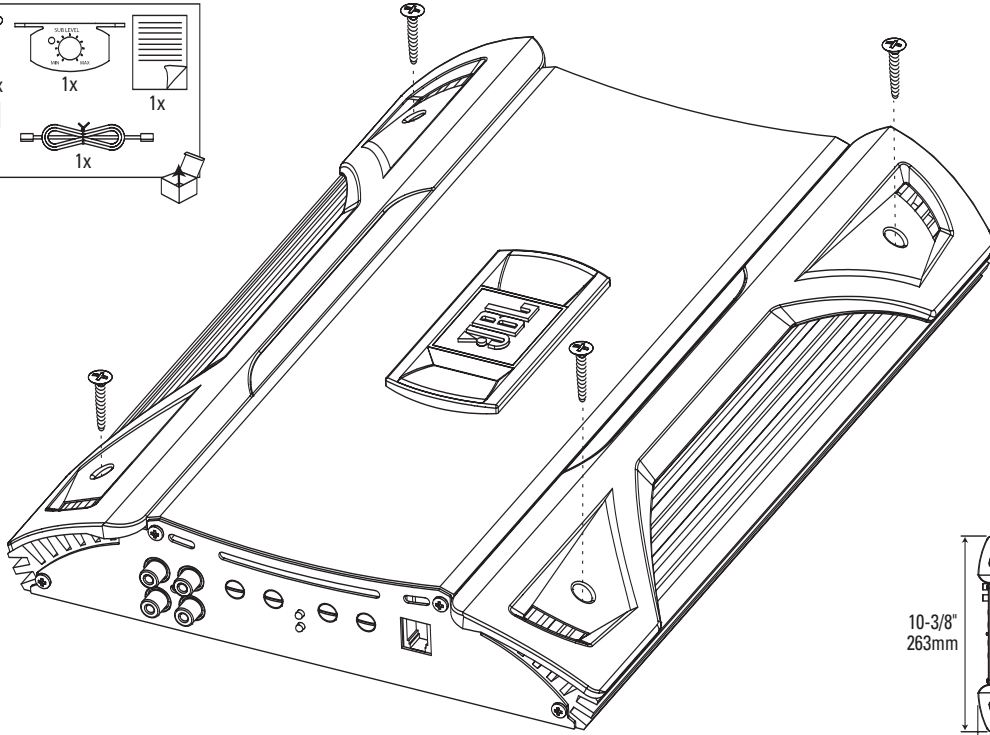
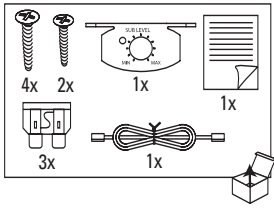

## GTO7001 CAR AUDIO SUBWOOFER AMPLIFIER OWNER'S MANUAL

### Installation Warnings and Tips

- Disconnect the negative (-) lead from your vehicle's battery.
- At the installation sites, locate and make a note of all fuel lines, hydraulic brake lines, vacuum lines and electrical wiring. Use extreme caution when cutting or drilling in and around these areas.
- Choose a safe mounting location away from moisture.
- Make sure there is sufficient air circulation at the mounting location for the amplifier to cool itself.
- Mount the amplifier, using the supplied hardware.

### Specifications

- 425W RMS x 1 channel @ 4 ohms and  $\leq 1\%$  THD + N\*
- 700W RMS x 1 channel @ 2 ohms and  $\leq 1\%$  THD + N\*
- THD + N: 0.02% (rated power @ 4 ohms)
- Signal-to-noise ratio: 80dBA (reference 1W into 4 ohms)\*
- Signal-to-noise ratio: 107dBA (reference rated power into 4 ohms)
- Frequency response: 20Hz – 330Hz (-3dB)
- Max power: 700 watts
- \* CEA-2006A-compliant

### 1 Speaker Output Connectors

- Connect the subwoofer to these terminals, observing proper polarity. Either + or - terminal may be used. Minimum total impedance is 2 ohms.

### 2 Fuses

- Replace only with the same type and rating.

### 3 Power Input Connectors

- +12V: Connect to the positive terminal of the vehicle's battery. 4 AWG wire is recommended. Install an appropriate fuse holder and fuse (75A minimum) within 18 inches of the battery. Make sure the wire is not damaged or pinched during installation. Install protective grommets when routing wires through the firewall or other sheet metal.
- GND: Connect to the vehicle's chassis. Refer to the picture below.

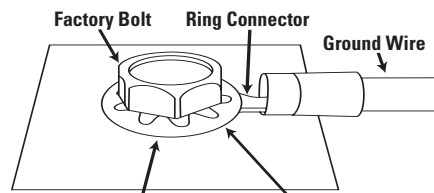

**Note:** Remove any paint below ring connector.

- REM: Connect to the "Remote Out" lead from the source unit or to a source of switched 12V+ (ACC).

### 4 Aux Output Connectors (RCA)

- Nonfiltered pass-through output. Connect to the input of an additional amplifier.

### 5 Input Connectors (RCA)

- Connect to the RCA outputs from the source unit or signal processor.

### 6 Input-Level Control

- Used to match the input level of the amplifier to the output level of the source unit.
- See 12 for the adjustment procedure.

### 7 Low-Pass Filter Frequency Control

- 12dB/octave low-pass filter, variable from 32Hz to 320Hz.
- See 13 for the adjustment procedure.

### 8 DBO (Dynamic Bass Optimization) Variable Subsonic High-Pass Filter With Variable Boost (Q)

- For woofers in tuned (vented) enclosures, set the Frequency control to a value 10Hz below the enclosure's resonance (tuned) frequency.
- For woofers in sealed boxes, set the control to any value you prefer between 30Hz and 50Hz.
- Set the Boost control according to your preference, being careful not to apply enough boost to damage your woofer(s).
- A** DBO High-Pass Filter Frequency control, variable between 10Hz and 100Hz. See above for appropriate settings.
- B** DBO Boost control provides up to 12dB of boost slightly above the high-pass filter's frequency. See above for appropriate settings.

### 9 Remote Level Control (RLC) Connector

- Connect the Remote Level Control (RLC) here, using the supplied RJ-11 cable.

### 10 Power On LED

- Illuminated when the amplifier is on.

### 11 Protect LED

- Illuminated under any of the following fault conditions: battery over/under voltage, short circuit in speaker wires, amplifier is too hot, amplifier's output circuit has failed (DC voltage is present in the amplifier's output).

### 12 Setting Input Level

- A** Turn Input Level control counterclockwise to 6V (minimum).
- B** With a dynamic music track playing, turn the head unit's volume control to the 3/4 position.
- C** Turn Input Level control clockwise until the bass output is proportionate to the output of the high-frequency speakers, according to your preference.
- D** Input level is now adjusted correctly.

### 13 Setting the Crossover

- A** Crossover setting for subwoofers.  
**Note:** Acceptable frequency ranges are indicated in gray.

### 14 Remote Level Control

- The Remote Level Control, if installed, will allow you to adjust the level of bass while seated in the listening position.

This product is designed for mobile applications and is not intended for connection to the mains.  
A valid serial number is required for warranty coverage.  
Features, specifications and appearance are subject to change without notice.



Harman Consumer Group, Inc.  
250 Crossways Park Drive, Woodbury, NY 11797  
www.jbl.com

© 2007 Harman International Industries, Incorporated. All rights reserved.

JBL is a trademark of Harman International Industries, Incorporated,  
registered in the United States and/or other countries.

Part No. GT070010M 8/07

**H** A Harman International Company



Declaration of Conformity

**CE**

We, Harman Consumer Group, Inc.  
2, route de Tours  
72500 Château du Loir  
France

declare in own responsibility that the product described in this owner's  
manual is in compliance with technical standards:  
EN 55013:2001+A1:2003  
EN 55020:2002+A1:2003

  
Klaus Leberz  
Harman Consumer Group, Inc.  
Château du Loir, France 8/07